

Bulletin 150  
**SMC™ Flex Smart Motor Controller**

Approximate Dimensions

Approximate Dimensions and Shipping Weights

Open Type Controllers

Dimensions are in millimeters (inches).  
 Dimensions are not intended for manufacturing purposes.

Rating (A)	Height	Width	Depth	Weight
5...85	321 (12.6)	150 (5.9)	203 (8.0)	5.7 kg (12.6 lbs)
108...135	443.7 (17.47)	196.4 (7.74)	205.2 (8.08)	15.0 kg (33 lbs)
201...251	560 (22.05)	225 (8.86)	253.8 (9.99)	30.4 kg (67 lbs)
317...480	600 (23.62)	290 (11.42)	276.5 (10.89)	45.8 kg (101 lbs)
625...780	1041.1 (41.0)	596.9 (23.5)	346.2 (13.63)	179 kg (395 lbs)
970...1250	1041.1 (41.0)	596.9 (23.5)	346.2 (13.63)	224 kg (495 lbs)

Enclosed Type Line-Connected Controllers

Factory-installed options may affect enclosure size requirements.  
 Exact dimensions can be obtained after order entry. Please consult your local Allen-Bradley distributor.

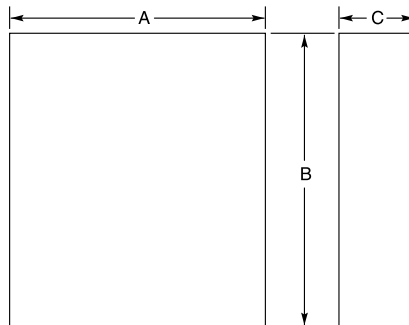

Controller Rating (A)	Disconnect Rating (A)	IP65 (Type 4/12)		
		B Height	A Width	C Depth
<b>Non-Combination Controller</b>				
5	—	610 (24)	406 (16)	254 (10)
25	—	610 (24)	406 (16)	254 (10)
43	—	610 (24)	406 (16)	254 (10)
60	—	610 (24)	406 (16)	254 (10)
85	—	610 (24)	406 (16)	254 (10)
108	—	762 (30)	610 (24)	305 (12)
135	—	762 (30)	610 (24)	305 (12)
201	—	965 (38)	762 (30)	356 (14)
251	—	965 (38)	762 (30)	356 (14)
317	—	1295 (51)	914 (36)	356 (14)
361	—	1295 (51)	914 (36)	356 (14)
480	—	1295 (51)	914 (36)	356 (14)
625	—	2286 (90)	762 (30)	508 (20)
780	—	2286 (90)	762 (30)	508 (20)
970*	—	2286 (90)	762 (30)	508 (20)
1250*	—	2286 (90)	762 (30)	508 (20)

\* 970...1250 rated devices are only available as Type 1 and require a door-mounted fan, capable of delivering 240 cfm.

Approximate Dimensions and Shipping Weights, Continued

Controller Rating (A)	Disconnect Rating (A)	IP65 (Type 4/12)		
		B Height	A Width	C Depth
<b>Combination Controllers with Fusible Disconnect</b>				
5	30 A/J	610 (24)	406 (16)	254 (10)
25	30 A/J	610 (24)	406 (16)	254 (10)
43	60 A/J	610 (24)	406 (16)	254 (10)
60	100 A/J	610 (24)	406 (16)	254 (10)
85	100 A/J	610 (24)	406 (16)	254 (10)
108	200 A/J	965 (38)	762 (30)	356 (14)
135	200 A/J	965 (38)	762 (30)	356 (14)
201	400 A/J	965 (38)	762 (30)	356 (14)
251	400 A/J	965 (38)	762 (30)	356 (14)
317	600 A/J	1524 (60)	965 (38)	356 (14)
361	600 A/J	1524 (60)	965 (38)	356 (14)
480	⊛ 600 A/J	1524 (60)	965 (38)	356 (14)
	‡ 800 A/L	2286 (90)	508 (20)	508 (20)
625	—	2286 (90)	1397 (55)	508 (20)
780	—	2286 (90)	1397 (55)	508 (20)
970*	—	2286 (90)	1651 (65)	508 (20)
1250*	—	2286 (90)	1651 (65)	508 (20)
<b>Combination Controllers with Circuit Breaker</b>				
5	15 A	610 (24)	406 (16)	254 (10)
25	30 A	610 (24)	406 (16)	254 (10)
43	80 A	610 (24)	406 (16)	254 (10)
60	100 A	610 (24)	406 (16)	254 (10)
85	125 A	610 (24)	406 (16)	254 (10)
108	175 A/175 A Plug	965 (38)	762 (30)	356 (14)
135	225 A/225 A Plug	965 (38)	762 (30)	356 (14)
201	300 A/300 A Plug	965 (38)	762 (30)	356 (14)
251	400 A/400 A Plug	965 (38)	762 (30)	356 (14)
317	600 A/500 A Plug	1295 (51)	914 (36)	356 (14)
361	600 A/600 A Plug	1295 (51)	914 (36)	356 (14)
480	800 A/800 A Plug	1295 (51)	914 (36)	356 (14)
625	—	2286 (90)	1397 (55)	508 (20)
780	—	2286 (90)	1397 (55)	508 (20)
970*	—	2286 (90)	1651 (65)	508 (20)
1250*	—	2286 (90)	1651 (65)	508 (20)

⊛ Use this row for 460V -58 and 575V -59.

‡ Use this row for 460V -59 and 575V -60 and -61.

\* 970...1250 rated devices are only available as Type 1 and require a door-mounted fan, capable of delivering 240 cfm.



**Bulletin 150 — Smart Motor Controllers — SMC-3 Smart Motor Controller**

The SMC-3 is a compact, simple to use, solid-state motor controller designed to operate 3-phase motors. It features a built-in overload relay and a built-in SCR bypass contactor on all three phases, allowing a smaller footprint than other soft starters on the market. This product is designed for many applications, including compressors, chillers, pumps, conveyors, and crushers. Modes of operation for the controller are as follows:

- Soft Start
- Current Limit Start
- Soft Stop
- Kick Start

The controllers offer two voltage ranges: 200...480V AC and 200...600V AC. All voltage ranges will operate at either 50 or 60 Hz.

- 1...480 A Range
- Built-In Electronic Motor Overload Protection
- Built-In SCR/Run Bypass
- Delta Compatibility

**Table of Contents**

Cat. No. Explanation ..... 28  
 Product Selection ..... 29  
 Typical Wiring Diagrams ..... 39  
 Specifications..... 41  
 Approximate Dimensions ..... 45  
 Enclosed Options ..... 47  
 Accessories ..... 47

**Standards Compliance/Approvals**

- UL 508
- CSA C22.2 No. 14
- EN/IEC 60947-4-2
- cULus Listed (Open Type) (File No. E96956)
- CE Marked (Open Type) per EMC Directive and Low Voltage Directive

**Modes of Operation**

**Soft Start**

This method has the most general application. The motor is raised from an initial torque value to full voltage. This initial torque can be adjusted to 0%, 25%, 35%, or 65% of locked rotor torque. The motor voltage is gradually increased during the acceleration ramp time, which can be adjusted from 2, 5, 10, 15, 20, 25, or 30 s.

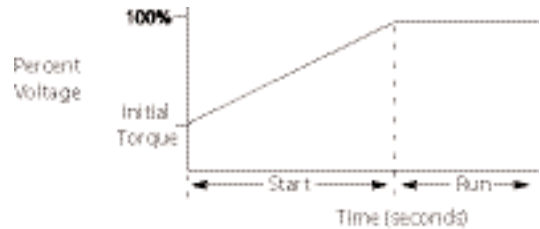

**Current Limit Start**

This starting mode is used when it is necessary to limit the maximum starting current. It can be adjusted to 150%, 250%, 350%, or 450% of full load amps. Start times are selectable from 2, 5, 10, 15, 20, 25, or 30 s.

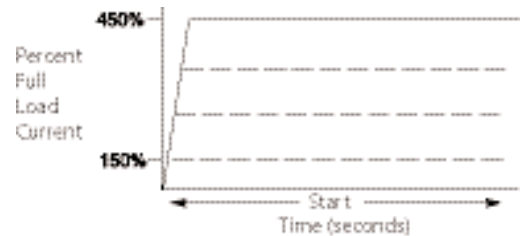

**Selectable Kick Start**

A kickstart, or boost, at the beginning of the start mode is intended to provide a current pulse of 450% of full load current. The kickstart time is adjustable from 0.5...1.5 seconds. This allows the motor to develop additional torque during starting for loads which may need a boost to get initial shaft rotation.

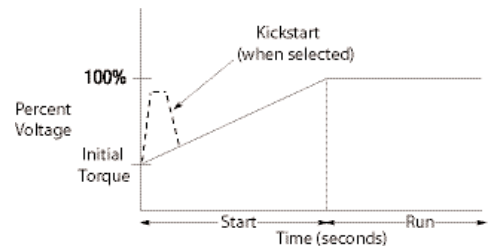

## Modes of Operation, Continued

### Soft Stop

The Soft Stop function can be used with applications that require an extended stop time. When enabled, the voltage ramp down time can be selected to one, two, or three times the starting time. The motor will stop when the motor voltage drops to a point where the load torque is greater than the motor torque.

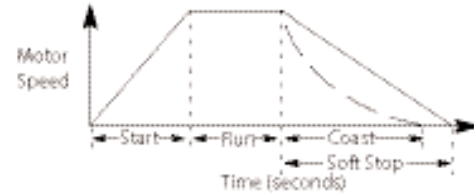

## Description of Features

### Electronic Motor Overload Protection

The SMC-3 controller incorporates, as standard, electronic motor overload protection. This motor overload protection is accomplished electronically with the use of current transformers on each of the three phases. The controller's overload protection is programmable, providing the user with flexibility. The overload trip class selection consists of either OFF, 10, 15, or 20. The trip current is easily selected by adjusting the rotary potentiometer to the motor full load current rating. Trip reset is selectable to either automatic or manual mode.

**Note:** Trip rating is 120% of dial setting.

### Over-temperature

The SMC-3 monitors the SCR temperature by means of internal thermistors. When the power poles maximum rated temperature is reached, the microcomputer switches off the SMC, a TEMP fault is indicated via LED, and the 97/98 fault contact closes.

### Phase Reversal Protection

When enabled via a DIP switch, 3-phase input power will be verified before starting. If input power phasing is detected to be incorrect, the start will be aborted and a fault indicated.

### Phase Loss/Open Load

The unit will not attempt a start if there is a single-phase condition on the line. This protects from motor burnout during single-phase starting.

### Phase Imbalance

The unit monitors for imbalance between phase currents. To prevent motor damage, the unit will trip if the difference between the minimum phase current and the maximum phase current exceeds 65% for 3 seconds, and a fault will be indicated.

### Shorted SCR

Prior to every start and during starting, the unit will check all SCRs for shorts and unit load connections to the motor. If there is a shorted SCR in the SMC-3 and/or open load, the start will be aborted and a shorted SCR or open load fault will be indicated. This prevents damage from phase imbalance.

### Push to Test

The unit with control wiring can be tested for fault conditions by using the Push to Test function. Hold down the Reset button for 7 seconds to activate the fault Aux (97, 98) and shut down the SMC-3. To clear, either push the Reset button or cycle control power to the device.

### LED Description (Number of Flashes)

1. Overload
2. Overtemperature
3. Phase Reversal
4. Phase Loss/Open Load
5. Phase Imbalance
6. Shorted SCR
7. Test

Open and Non-Combination

150 – C 30 F B D – 8L  
*a b c d e f g*

*a*

Bulletin Number	
Code	Description
150	Solid-State Controller

*b*

Controller Type	
Code	Description
C	SMC-3

*c*

Ampere Ratings	
Code	Description
3	3 A
9	9 A
16	16 A
19	19 A
25	25 A
30	30 A
37	37 A
43	43 A
60	60 A
85	85 A
108	108 A
135	135 A
201	201 A
251	251 A
317	317 A
361	361 A
480	480 A

*d*

Enclosure Type	
Code	Description
N	Open
F	IP65 (NEMA 4/12)

*e*

Input Line Voltage Open Type	
Code	Description
B	200...460V AC, 3-Phase, 50/60 Hz
C	200...600V AC, 3-Phase, 50/60 Hz
Non-Combination Enclosed Only	
H	200...208V AC, 3-Phase, 50/60 Hz
A	230V AC, 3-Phase, 50/60 Hz
B	400...460V AC, 3-Phase, 50/60 Hz
C	500...575V AC, 3-Phase, 50/60 Hz

*f*

Control Voltage	
Code	Description
D	100...240V AC
R	24V AC/DC (Open Type only)

*g*

Options (see page 47 for a full listing)	
Code	Description
8L	Line Mounted Protective Module (Enclosed Type only)
Load-side MOVs are not available when used with inside-the-delta connections. MOVs can be field installed for open type units.	

Combination

152H – C 30 F BD 43 – 8L  
*a b c d e f g*

*a*

Bulletin Number	
Code	Description
152H	Solid-State Controller with Fusible Disconnect
153H	Solid-State Controller with Circuit Breaker

*b*

Controller Type	
Code	Description
C	SMC-3

*c*

Ampere Ratings	
Code	Description
3	3 A
9	9 A
16	16 A
19	19 A
25	25 A
30	30 A
37	37 A
43	43 A
60	60 A
85	85 A
108	108 A
135	135 A
201	201 A
251	251 A
317	317 A
361	361 A
480	480 A

*d*

Enclosure Type	
Code	Description
F	IP65 (NEMA 4/12)

*e*

Input Line Voltage Open Type	
Code	Description
HD	200...208V AC, 3-Phase, 50/60 Hz
AD	230V AC, 3-Phase, 50/60 Hz
BD	400...460V AC, 3-Phase, 50/60 Hz
CD	500...575V AC, 3-Phase, 50/60 Hz

*f*

Horsepower									
Cat. No.	Hp Rating	Cat. No.	Hp Rating	Cat. No.	Hp Rating	Cat. No.	Hp Rating	Cat. No.	Hp Rating
33	0.5	39	5	46	40	52	150	60	450
34	0.75	40	7.5	47	50	54	200	61	500
35	1	41	10	48	60	56	250	62	600
36	1.5	42	15	49	75	57	300	63	700
37	2	43	20	50	100	58	350	65	800
38	3	44	25	51	125	59	400	67	1000
—	—	45	30	—	—	—	—	—	—

*g*

Options (see page 47 for a full listing)	
Code	Description
8L	Line Mounted Protective Module (Enclosed Type only)
Load-side MOVs are not available when used with inside-the-delta connections.	

**Open Type and Non-Combination Enclosed (IP65, NEMA 4/12) Controllers — For use with Line-Connected Motors**

Rated Voltage [V AC]	Motor Current (A)*	Max. kW, 50Hz	Max. Hp, 60 Hz	Control Power	Open Type — Line-Connected Motors	IP65 (Type 4/12) Enclosed Non-Combination Controllers§
					Cat. No.	Cat. No.
200/208	1...3	—	0.5	100...240V AC, 50/60 Hz	150-C3NBD	150-C3FHD
		—		24V AC/DC	150-C3NBR	—
	3...9	—	0.75...2	100...240V AC, 50/60 Hz	150-C9NBD	150-C9FHD
		—		24V AC/DC	150-C9NBR	—
	5.3...16	—	1.5...3	100...240V AC, 50/60 Hz	150-C16NBD	150-C16FHD
		—		24V AC/DC	150-C16NBR	—
	6.3...19	—	1.5...3	100...240V AC, 50/60 Hz	150-C19NBD	150-C25FHD
		—		24V AC/DC	150-C19NBR	—
	9.2...27.7	—	3...7.5	100...240V AC, 50/60 Hz	150-C25NBD	150-C25FHD
		—		24V AC/DC	150-C25NBR	—
	10...30	—	3...7.5	100...240V AC, 50/60 Hz	150-C30NBD	150-C30FHD
		—		24V AC/DC	150-C30NBR	—
	12.3...37	—	5...10	100...240V AC, 50/60 Hz	150-C37NBD	150-C37FHD
		—		24V AC/DC	150-C37NBR	—
	14.3...43	—	5...10	100...240V AC, 50/60 Hz	150-C43NBD	150-C43FHD
		—		24V AC/DC	150-C43NBR	—
	20...60	—	7.5...15	100...240V AC, 50/60 Hz	150-C60NBD	150-C60FHD
		—		24V AC/DC	150-C60NBR	—
	28.3...85	—	10...25	100...240V AC, 50/60 Hz	150-C85NBD	150-C85FHD
		—		24V AC/DC	150-C85NBR	—
27...108	—	20...30	100...240V AC, 50/60 Hz	150-C108NBD	150-C108FHD	
	—		24V AC/DC♣	150-C108NBR	—	
34...135	—	25...40	100...240V AC, 50/60 Hz	150-C135NBD	150-C135FHD	
	—		24V AC/DC♣	150-C135NBR	—	
67...201	—	40...60	100...240V AC, 50/60 Hz	150-C201NBD	150-C201FHD	
	—		24V AC/DC♣	150-C201NBR	—	
84...251	—	50...75	100...240V AC, 50/60 Hz	150-C251NBD	150-C251FHD	
	—		24V AC/DC♣	150-C251NBR	—	
106...317	—	60...100	100...240V AC, 50/60 Hz	150-C317NBD	150-C317FHD	
	—		24V AC/DC♣	150-C317NBR	—	
120...361	—	75...125	100...240V AC, 50/60 Hz	150-C361NBD	150-C361FHD	
	—		24V AC/DC♣	150-C361NBR	—	
160...480	—	100...150	100...240V AC, 50/60 Hz	150-C480NBD	150-C480FHD	
	—		24V AC/DC♣	150-C480NBR	—	

\* Motor FLA rating should fall within specified current range for unit to operate properly.

§ These controllers require a separate 100...240V, 50/60 Hz single-phase control source. To add a control circuit transformer to the enclosure, add the appropriate option code to the catalog string.

♣ Separate 120V or 240V single phase is required for fan operation.

Open Type and Non-Combination Enclosed (IP65, NEMA 4/12) Controllers — For use with Line-Connected Motors, Continued

Rated Voltage [V AC]	Motor Current (A)*	Max. kW, 50 Hz	Max. Hp, 60 Hz	Control Power	Open Type — Line-Connected Motors	IP65 (Type 4/12) Enclosed Non-Combination Controllers§
					Cat. No.	Cat. No.
230	1...3	0.55	0.5	100...240V AC, 50/60 Hz	150-C3NBD	150-C3FAD
				24V AC/DC	150-C3NBR	—
	3...9	2.2	0.75...2	100...240V AC, 50/60 Hz	150-C9NBD	150-C9FAD
				24V AC/DC	150-C9NBR	—
	5.3...16	4	1.5...5	100...240V AC, 50/60 Hz	150-C16NBD	150-C16FAD
				24V AC/DC	150-C16NBR	—
	6.3...19	4	2...5	100...240V AC, 50/60 Hz	150-C19NBD	150-C25FAD
				24V AC/DC	150-C19NBR	—
	9.2...27.7	5.5	3...7.5	100...240V AC, 50/60 Hz	150-C25NBD	150-C25FAD
				24V AC/DC	150-C25NBR	—
	10...30	7.5	5...10	100...240V AC, 50/60 Hz	150-C30NBD	150-C30FAD
				24V AC/DC	150-C30NBR	—
	12.3...37	7.5	5...10	100...240V AC, 50/60 Hz	150-C37NBD	150-C37FAD
				24V AC/DC	150-C37NBR	—
	14.3...43	11	5...15	100...240V AC, 50/60 Hz	150-C43NBD	150-C43FAD
				24V AC/DC	150-C43NBR	—
	20...60	15	7.5...20	100...240V AC, 50/60 Hz	150-C60NBD	150-C60FAD
				24V AC/DC	150-C60NBR	—
	28.3...85	22	15...30	100...240V AC, 50/60 Hz	150-C85NBD	150-C85FAD
				24V AC/DC	150-C85NBR	—
27...108	30	20...40	100...240V AC, 50/60 Hz	150-C108NBD	150-C108FAD	
			24V AC/DC♣	150-C108NBR	—	
34...135	37	25...50	100...240V AC, 50/60 Hz	150-C135NBD	150-C135FAD	
			24V AC/DC♣	150-C135NBR	—	
67...201	55	40...75	100...240V AC, 50/60 Hz	150-C201NBD	150-C201FAD	
			24V AC/DC♣	150-C201NBR	—	
84...251	75	50...100	100...240V AC, 50/60 Hz	150-C251NBD	150-C251FAD	
			24V AC/DC♣	150-C251NBR	—	
106...317	90	60...125	100...240V AC, 50/60 Hz	150-C317NBD	150-C317FAD	
			24V AC/DC♣	150-C317NBR	—	
120...361	110	75...150	100...240V AC, 50/60 Hz	150-C361NBD	150-C361FAD	
			24V AC/DC♣	150-C361NBR	—	
160...480	132	100...200	100...240V AC, 50/60 Hz	150-C480NBD	150-C480FAD	
			24V AC/DC♣	150-C480NBR	—	

\* Motor FLA rating should fall within specified current range for unit to operate properly.

§ These controllers require a separate 100...240V, 50/60 Hz single-phase control source. To add a control circuit transformer to the enclosure, add the appropriate option code to the catalog string.

♣ Separate 120V or 240V single phase is required for fan operation.



**Open Type and Non-Combination Enclosed (IP65, NEMA 4/12) Controllers — For use with Line-Connected Motors, Continued**

Rated Voltage [V AC]	Motor Current (A)*	Max. kW, 50 Hz	Max. Hp, 60 Hz	Control Power	Open Type — Line-Connected Motors	IP65 (Type 4/12) Enclosed Non-Combination Controllers§
					Cat. No.	Cat. No.
380/400/ 415/460	1...3	1.1	0.5...1.5	100...240V AC, 50/60 Hz	150-C3NBD	150-C3FBD
				24V AC/DC	150-C3NBR	—
	3...9	4	1.5...5	100...240V AC, 50/60 Hz	150-C9NBD	150-C9FBD
				24V AC/DC	150-C9NBR	—
	5.3...16	7.5	5...10	100...240V AC, 50/60 Hz	150-C16NBD	150-C16FBD
				24V AC/DC	150-C16NBR	—
	6.3...19	7.5	5...10	100...240V AC, 50/60 Hz	150-C19NBD	150-C25FBD
				24V AC/DC	150-C19NBR	—
	9.2...27.7	11	7.5...15	100...240V AC, 50/60 Hz	150-C25NBD	150-C25FBD
				24V AC/DC	150-C25NBR	—
	10...30	15	7.5...20	100...240V AC, 50/60 Hz	150-C30NBD	150-C30FBD
				24V AC/DC	150-C30NBR	—
	12.3...37	18.5	10...25	100...240V AC, 50/60 Hz	150-C37NBD	150-C37FBD
				24V AC/DC	150-C37NBR	—
	14.3...43	22	10...30	100...240V AC, 50/60 Hz	150-C43NBD	150-C43FBD
				24V AC/DC	150-C43NBR	—
	20...60	30	15...40	100...240V AC, 50/60 Hz	150-C60NBD	150-C60FBD
				24V AC/DC	150-C60NBR	—
	28.3...85	45	25...60	100...240V AC, 50/60 Hz	150-C85NBD	150-C85FBD
				24V AC/DC	150-C85NBR	—
27...108	55	50...75	100...240V AC, 50/60 Hz	150-C108NBD	150-C108FBD	
			24V AC/DC♣	150-C108NBR	—	
34...135	75	60...100	100...240V AC, 50/60 Hz	150-C135NBD	150-C135FBD	
			24V AC/DC♣	150-C135NBR	—	
67...201	95...110	75...150	100...240V AC, 50/60 Hz	150-C201NBD	150-C201FBD	
			24V AC/DC♣	150-C201NBR	—	
84...251	95...132	100...200	100...240V AC, 50/60 Hz	150-C251NBD	150-C251FBD	
			24V AC/DC♣	150-C251NBR	—	
106...317	95...160	125...250	100...240V AC, 50/60 Hz	150-C317NBD	150-C317FBD	
			24V AC/DC♣	150-C317NBR	—	
120...361	110...200	250...300	100...240V AC, 50/60 Hz	150-C361NBD	150-C361FBD	
			24V AC/DC♣	150-C361NBR	—	
160...480	160...250	300...400	100...240V AC, 50/60 Hz	150-C480NBD	150-C480FBD	
			24V AC/DC♣	150-C480NBR	—	

♣ Motor FLA rating should fall within specified current range for unit to operate properly.

§ These controllers require a separate 100...240V, 50/60 Hz single-phase control source. To add a control circuit transformer to the enclosure, add the appropriate option code to the catalog string.

♣ Separate 120V or 240V single phase is required for fan operation.



Open Type and Non-Combination Enclosed (IP65, NEMA 4/12) Controllers — For use with Line-Connected Motors, Continued

Rated Voltage [V AC]	Motor Current (A)*	Max. kW, 50 Hz	Max. Hp, 60 Hz	Control Power	Open Type — Line-Connected Motors	IP65 (Type 4/12) Enclosed Non-Combination Controllers§
					Cat. No.	Cat. No.
500/575	1...3	1.5	0.75...2	100...240V AC, 50/60 Hz	150-C3NCD	150-C3FCD
				24V AC/DC	150-C3NCR	—
	3...9	5.5	3...7.5	100...240V AC, 50/60 Hz	150-C9NCD	150-C9FCD
				24V AC/DC	150-C9NCR	—
	5.3...16	7.5	5...10	100...240V AC, 50/60 Hz	150-C16NCD	150-C16FCD
				24V AC/DC	150-C16NCR	—
	6.3...19	11	7.5...15	100...240V AC, 50/60 Hz	150-C19NCD	150-C25FCD
				24V AC/DC	150-C19NCR	—
	9.2...27.7	15	7.5...20	100...240V AC, 50/60 Hz	150-C25NCD	150-C25FCD
				24V AC/DC	150-C25NCR	—
	10...30	18.5	10...25	100...240V AC, 50/60 Hz	150-C30NCD	150-C30FCD
				24V AC/DC	150-C30NCR	—
	12.3...37	22	15...30	100...240V AC, 50/60 Hz	150-C37NCD	150-C37FCD
				24V AC/DC	150-C37NCR	—
	14.3...43	22	15...40	100...240V AC, 50/60 Hz	150-C43NCD	150-C43FCD
				24V AC/DC	150-C43NCR	—
	20...60	37	20...50	100...240V AC, 50/60 Hz	150-C60NCD	150-C60FCD
				24V AC/DC	150-C60NCR	—
	28.3...85	55	30...75	100...240V AC, 50/60 Hz	150-C85NCD	150-C85FCD
				24V AC/DC	150-C85NCR	—
27...108	75	60...100	100...240V AC, 50/60 Hz	150-C108NCD	150-C108FCD	
			24V AC/DC♣	150-C108NCR	—	
34...135	90	75...125	100...240V AC, 50/60 Hz	150-C135NCD	150-C135FCD	
			24V AC/DC♣	150-C135NCR	—	
67...201	75...132	100...200	100...240V AC, 50/60 Hz	150-C201NCD	150-C201FCD	
			24V AC/DC♣	150-C201NCR	—	
84...251	90...160	125...250	100...240V AC, 50/60 Hz	150-C251NCD	150-C251FCD	
			24V AC/DC♣	150-C251NCR	—	
106...317	100...200	200...300	100...240V AC, 50/60 Hz	150-C317NCD	150-C317FCD	
			24V AC/DC♣	150-C317NCR	—	
120...361	132...250	200...350	100...240V AC, 50/60 Hz	150-C361NCD	150-C361FCD	
			24V AC/DC♣	150-C361NCR	—	
160...480	200...315	250...500	100...240V AC, 50/60 Hz	150-C480NCD	150-C480FCD	
			24V AC/DC♣	150-C480NCR	—	

\* Motor FLA rating should fall within specified current range for unit to operate properly.

§ These controllers require a separate 100...240V, 50/60 Hz single-phase control source. To add a control circuit transformer to the enclosure, add the appropriate option code to the catalog string.

♣ Separate 120V or 240V single phase is required for fan operation.



**Open Type Controllers — For use with Delta-Connected Motors**

Rated Voltage [V AC]	Motor Current (A)*	Max. kW, 50Hz	Max. Hp, 60 Hz	Control Power	Open Type
					Cat. No.
200/208	1.7...5.1	—	1	100...240V AC, 50/60 Hz	150-C3NBD
		—		24V AC/DC	150-C3NBR
	5.1...16	—	1.5...3	100...240V AC, 50/60 Hz	150-C9NBD
		—		24V AC/DC	150-C9NBR
	9.1...27.6	—	3...7.5	100...240V AC, 50/60 Hz	150-C16NBD
		—		24V AC/DC	150-C16NBR
	10.9...32.8	—	3...10	100...240V AC, 50/60 Hz	150-C19NBD
		—		24V AC/DC	150-C19NBR
	14.3...43	—	3...10	100...240V AC, 50/60 Hz	150-C25NBD
		—		24V AC/DC	150-C25NBR
	17.3...52	—	5...10	100...240V AC, 50/60 Hz	150-C30NBD
		—		24V AC/DC	150-C30NBR
	21...64	—	7.5...20	100...240V AC, 50/60 Hz	150-C37NBD
		—		24V AC/DC	150-C37NBR
	25...74	—	7.5...20	100...240V AC, 50/60 Hz	150-C43NBD
		—		24V AC/DC	150-C43NBR
	34.6...104	—	15...30	100...240V AC, 50/60 Hz	150-C60NBD
		—		24V AC/DC	150-C60NBR
	50...147	—	15...40	100...240V AC, 50/60 Hz	150-C85NBD
		—		24V AC/DC	150-C85NBR
	47...187	—	20...60	100...240V AC, 50/60 Hz	150-C108NBD
		—		24V AC/DC*	150-C108NBR
	59...234	—	20...75	100...240V AC, 50/60 Hz	150-C135NBD
		—		24V AC/DC*	150-C135NBR
116...348	—	75...100	100...240V AC, 50/60 Hz	150-C201NBD	
	—		24V AC/DC*	150-C201NBR	
145...435	—	100...150	100...240V AC, 50/60 Hz	150-C251NBD	
	—		24V AC/DC*	150-C251NBR	
183...549	—	100...200	100...240V AC, 50/60 Hz	150-C317NBD	
	—		24V AC/DC*	150-C317NBR	
208...625	—	125...200	100...240V AC, 50/60 Hz	150-C361NBD	
	—		24V AC/DC*	150-C361NBR	
277...831	—	200...300	100...240V AC, 50/60 Hz	150-C480NBD	
	—		24V AC/DC*	150-C480NBR	

\* Motor FLA rating should fall within specified current range for unit to operate properly.

\* Separate 120V or 240V single phase is required for fan operation.

Bulletin 150  
**Smart Motor Controllers — SMC™-3**  
 Product Selection, Continued

Open Type Controllers — For use with Delta-Connected Motors, Continued

Rated Voltage [V AC]	Motor Current (A)*	Max. kW, 50 Hz	Max. Hp, 60 Hz	Control Power	Open Type
					Cat. No.
230	1.7...5.1	0.25...1.1	1	100...240V AC, 50/60 Hz	150-C3NBD
				24V AC/DC	150-C3NBR
	5.1...16	1.1...4	1...5	100...240V AC, 50/60 Hz	150-C9NBD
				24V AC/DC	150-C9NBR
	9.1...27.6	2.2...7.5	3...7.5	100...240V AC, 50/60 Hz	150-C16NBD
				24V AC/DC	150-C16NBR
	10.9...32.8	2.2...7.5	3...10	100...240V AC, 50/60 Hz	150-C19NBD
				24V AC/DC	150-C19NBR
	14.3...43	4...11	3...15	100...240V AC, 50/60 Hz	150-C25NBD
				24V AC/DC	150-C25NBR
	17.3...52	4...15	5...15	100...240V AC, 50/60 Hz	150-C30NBD
				24V AC/DC	150-C30NBR
	21...64	5.5...18.5	7.5...20	100...240V AC, 50/60 Hz	150-C37NBD
				24V AC/DC	150-C37NBR
	25...74	5.5...22	7.5...25	100...240V AC, 50/60 Hz	150-C43NBD
				24V AC/DC	150-C43NBR
	34.6...104	7.5...30	15...40	100...240V AC, 50/60 Hz	150-C60NBD
				24V AC/DC	150-C60NBR
	50...147	15...45	20...50	100...240V AC, 50/60 Hz	150-C85NBD
				24V AC/DC	150-C85NBR
47...187	55	20...60	100...240V AC, 50/60 Hz	150-C108NBD	
			24V AC/DC*	150-C108NBR	
59...234	75	25...75	100...240V AC, 50/60 Hz	150-C135NBD	
			24V AC/DC*	150-C135NBR	
116...348	110	75...125	100...240V AC, 50/60 Hz	150-C201NBD	
			24V AC/DC*	150-C201NBR	
145...435	132	100...150	100...240V AC, 50/60 Hz	150-C251NBD	
			24V AC/DC*	150-C251NBR	
183...549	160	125...200	100...240V AC, 50/60 Hz	150-C317NBD	
			24V AC/DC*	150-C317NBR	
208...625	200	150...250	100...240V AC, 50/60 Hz	150-C361NBD	
			24V AC/DC*	150-C361NBR	
277...831	250	200...300	100...240V AC, 50/60 Hz	150-C480NBD	
			24V AC/DC*	150-C480NBR	

\* Motor FLA rating should fall within specified current range for unit to operate properly.

\* Separate 120V or 240V single phase is required for fan operation.

**Open Type Controllers — For use with Delta-Connected Motors, Continued**

Rated Voltage [V AC]	Motor Current (A)*	Max. kW, 50 Hz	Max. Hp, 60 Hz	Control Power	Open Type
					Cat. No.
380/400/415/460	1.7...5.1	0.55...2.2	0.5...2	100...240V AC, 50/60 Hz	150-C3NBD
				24V AC/DC	150-C3NBR
	5.1...16	2.2...7.5	2...7.5	100...240V AC, 50/60 Hz	150-C9NBD
				24V AC/DC	150-C9NBR
	9.1...27.6	4...11	5...15	100...240V AC, 50/60 Hz	150-C16NBD
				24V AC/DC	150-C16NBR
	10.9...32.8	4...15	5...15	100...240V AC, 50/60 Hz	150-C19NBD
				24V AC/DC	150-C19NBR
	14.3...43	5.5...22	7.5...20	100...240V AC, 50/60 Hz	150-C25NBD
				24V AC/DC	150-C25NBR
	17.3...52	7.5...22	7.5...30	100...240V AC, 50/60 Hz	150-C30NBD
				24V AC/DC	150-C30NBR
	21...64	7.5...30	10...40	100...240V AC, 50/60 Hz	150-C37NBD
				24V AC/DC	150-C37NBR
	25...74	11...37	10...50	100...240V AC, 50/60 Hz	150-C43NBD
				24V AC/DC	150-C43NBR
	34.6...104	15...55	20...75	100...240V AC, 50/60 Hz	150-C60NBD
				24V AC/DC	150-C60NBR
	50...147	22...75	25...100	100...240V AC, 50/60 Hz	150-C85NBD
				24V AC/DC	150-C85NBR
47...187	90	40...150	100...240V AC, 50/60 Hz	150-C108NBD	
			24V AC/DC*	150-C108NBR	
59...234	132	50...150	100...240V AC, 50/60 Hz	150-C135NBD	
			24V AC/DC*	150-C135NBR	
116...348	160	150...250	100...240V AC, 50/60 Hz	150-C201NBD	
			24V AC/DC*	150-C201NBR	
145...435	250	200...350	100...240V AC, 50/60 Hz	150-C251NBD	
			24V AC/DC*	150-C251NBR	
183...549	315	250...450	100...240V AC, 50/60 Hz	150-C317NBD	
			24V AC/DC*	150-C317NBR	
208...625	355	300...500	100...240V AC, 50/60 Hz	150-C361NBD	
			24V AC/DC*	150-C361NBR	
277...831	450	350...700	100...240V AC, 50/60 Hz	150-C480NBD	
			24V AC/DC*	150-C480NBR	

\* Motor FLA rating should fall within specified current range for unit to operate properly.

\* Separate 120V or 240V single phase is required for fan operation.

Bulletin 150  
**Smart Motor Controllers — SMC™-3**  
 Product Selection, Continued

**Open Type Controllers — For use with Delta-Connected Motors, Continued**

Rated Voltage [V AC]	Motor Current (A)*	Max. kW, 50 Hz	Max. Hp, 60 Hz	Control Power	Open Type
					Cat. No.
500/575	1.7...5.1	0.75...3	1...3	100...240V AC, 50/60 Hz	150-C3NCD
				24V AC/DC	150-C3NCR
	5.1...16	3...7.5	3...10	100...240V AC, 50/60 Hz	150-C9NCD
				24V AC/DC	150-C9NCR
	9.1...27.6	5.5...15	7.5...20	100...240V AC, 50/60 Hz	150-C16NCD
				24V AC/DC	150-C16NCR
	10.9...32.8	5.5...22	7.5...30	100...240V AC, 50/60 Hz	150-C19NCD
				24V AC/DC	150-C19NCR
	14.3...43	7.5...22	10...40	100...240V AC, 50/60 Hz	150-C25NCD
				24V AC/DC	150-C25NCR
	17.3...52	11...30	15...50	100...240V AC, 50/60 Hz	150-C30NCD
				24V AC/DC	150-C30NCR
	21...64	11...37	15...60	100...240V AC, 50/60 Hz	150-C37NCD
				24V AC/DC	150-C37NCR
	25...74	15...45	20...60	100...240V AC, 50/60 Hz	150-C43NCD
				24V AC/DC	150-C43NCR
	34.6...104	22...55	30...100	100...240V AC, 50/60 Hz	150-C60NCD
				24V AC/DC	150-C60NCR
	50...147	30...90	40...150	100...240V AC, 50/60 Hz	150-C85NCD
				24V AC/DC	150-C85NCR
47...187	132	50...150	100...240V AC, 50/60 Hz	150-C108NCD	
			24V AC/DC*	150-C108NCR	
59...234	160	60...200	100...240V AC, 50/60 Hz	150-C135NCD	
			24V AC/DC*	150-C135NCR	
116...348	250	250...300	100...240V AC, 50/60 Hz	150-C201NCD	
			24V AC/DC*	150-C201NCR	
145...435	315	250...400	100...240V AC, 50/60 Hz	150-C251NCD	
			24V AC/DC*	150-C251NCR	
183...549	400	300...500	100...240V AC, 50/60 Hz	150-C317NCD	
			24V AC/DC*	150-C317NCR	
208...625	450	350...600	100...240V AC, 50/60 Hz	150-C361NCD	
			24V AC/DC*	150-C361NCR	
277...831	560	400...900	100...240V AC, 50/60 Hz	150-C480NCD	
			24V AC/DC*	150-C480NCR	

\* Motor FLA rating should fall within specified current range for unit to operate properly.  
 \* Separate 120V or 240V single phase is required for fan operation.

Combination Enclosed (IP65, NEMA 4/12) Controllers with Fusible Disconnect or Circuit Breaker

Rated Voltage [V AC]	Current Rating (A)	kW	Hp (0.5 = 1/2, 0.75 = 3/4, 7.5 = 7-1/2)	IP65 (Type 4/12) Enclosed Combination Controllers with Fusible Disconnect *	IP65 (Type 4/12) Enclosed Combination Controllers with Circuit Breaker *
				Cat. No.	Cat. No.
200/208	3	—	0.5	152H-C3FHD-33	153H-C3FHD-33
	9	—	0.75	152H-C9FHD-34	153H-C9FHD-34
	9	—	1	152H-C9FHD-35	153H-C9FHD-35
	9	—	1.5	152H-C9FHD-36	153H-C9FHD-36
	16	—	2	152H-C16FHD-37	153H-C16FHD-37
	16	—	3	152H-C16FHD-38	153H-C16FHD-38
	25	—	5	152H-C25FHD-39	153H-C25FHD-39
	37	—	7.5	152H-C37FHD-40	153H-C37FHD-40
	43	—	10	152H-C43FHD-41	153H-C43FHD-41
	60	—	15	152H-C60FHD-42	153H-C60FHD-42
	85	—	20	152H-C85FHD-43	153H-C85FHD-43
	85	—	25	152H-C85FHD-44	153H-C85FHD-44
	108	—	30	152H-C108FHD-45	153H-C108FHD-45
	135	—	40	152H-C135FHD-46	153H-C135FHD-46
	201	—	60	152H-C201FHD-48	153H-C201FHD-48
	251	—	75	152H-C251FHD-49	153H-C251FHD-49
	317	—	100	152H-C317FHD-50	153H-C317FHD-50
	361	—	125	152H-C361FHD-51	153H-C361FHD-51
480	—	150	152H-C480FHD-52	153H-C480FHD-52	
230	3	0.37	0.5	152H-C3FAD-33	153H-C3FAD-33
	9	0.55	0.75	152H-C9FAD-34	153H-C9FAD-34
	9	0.75	1	152H-C9FAD-35	153H-C9FAD-35
	9	1.1	1.5	152H-C9FAD-36	153H-C9FAD-36
	9	1.5	2	152H-C9FAD-37	153H-C9FAD-37
	16	2.2	3	152H-C16FAD-38	153H-C16FAD-38
	25	3.7	5	152H-C25FAD-39	153H-C25FAD-39
	30	5.5	7.5	152H-C30FAD-40	153H-C30FAD-40
	37	7.5	10	152H-C37FAD-41	153H-C37FAD-41
	43	11	15	152H-C43FAD-42	153H-C43FAD-42
	60	15	20	152H-C60FAD-43	153H-C60FAD-43
	85	18.5	25	152H-C85FAD-44	153H-C85FAD-44
	85	22	30	152H-C85FAD-45	153H-C85FAD-45
	108	30	40	152H-C108FAD-46	153H-C108FAD-46
	135	37	50	152H-C135FAD-47	153H-C135FAD-47
	201	55	75	152H-C201FAD-49	153H-C201FAD-49
	251	75	100	152H-C251FAD-50	153H-C251FAD-50
	317	90	125	152H-C317FAD-51	153H-C317FAD-51
361	110	150	152H-C361FAD-52	153H-C361FAD-52	
480	147	200	152H-C480FAD-54	153H-C480FAD-54	

\* These controllers require a separate 100...240V, 50/60 Hz single-phase control source. To add a control circuit transformer to the enclosure, add the appropriate option code to the catalog string.

Combination Enclosed (IP65, NEMA 4/12) Controllers with Fusible Disconnect or Circuit Breaker, Continued

Rated Voltage [V AC]	Current Rating (A)	kW	Hp (0.5 = 1/2, 0.75 = 3/4, 7.5 = 7-1/2)	IP65 (Type 4/12) Enclosed Combination Controllers with Fusible Disconnect *	IP65 (Type 4/12) Enclosed Combination Controllers with Circuit Breaker *
				Cat. No.	Cat. No.
460	3	0.37	0.5	152H-C3FBD-33	153H-C3FBD-33
	3	0.55	0.75	152H-C3FBD-34	153H-C3FBD-34
	3	0.75	1	152H-C3FBD-35	153H-C3FBD-35
	9	1.1	1.5	152H-C9FBD-36	153H-C9FBD-36
	9	1.5	2	152H-C9FBD-37	153H-C9FBD-37
	9	2.2	3	152H-C9FBD-38	153H-C9FBD-38
	16	3.7	5	152H-C16FBD-39	153H-C16FBD-39
	16	5.5	7.5	152H-C16FBD-40	153H-C16FBD-40
	25	7.5	10	152H-C25FBD-41	153H-C25FBD-41
	30	11	15	152H-C30FBD-42	153H-C30FBD-42
	37	15	20	152H-C37FBD-43	153H-C37FBD-43
	43	18.5	25	152H-C43FBD-44	153H-C43FBD-44
	43	22	30	152H-C43FBD-45	153H-C43FBD-45
	60	30	40	152H-C60FBD-46	153H-C60FBD-46
	85	37	50	152H-C85FBD-47	153H-C85FBD-47
	85	45	60	152H-C85FBD-48	153H-C85FBD-48
	108	55	75	152H-C108FBD-49	153H-C108FBD-49
	135	75	100	152H-C135FBD-50	153H-C135FBD-50
	201	110	150	152H-C201FBD-52	153H-C201FBD-52
	251	147	200	152H-C251FBD-54	153H-C251FBD-54
317	185	250	152H-C317FBD-56	153H-C317FBD-56	
361	220	300	152H-C361FBD-57	153H-C361FBD-57	
480	295	400	152H-C480FBD-59	153H-C480FBD-59	
500/575	3	0.55	0.75	152H-C3FCD-34	153H-C3FCD-34
	3	0.75	1	152H-C3FCD-35	153H-C3FCD-35
	9	1.1	1.5	152H-C9FCD-36	153H-C9FCD-36
	9	1.5	2	152H-C9FCD-37	153H-C9FCD-37
	9	2.2	3	152H-C9FCD-38	153H-C9FCD-38
	9	3.7	5	152H-C9FCD-39	153H-C9FCD-39
	16	5.5	7.5	152H-C16FCD-40	153H-C16FCD-40
	16	7.5	10	152H-C16FCD-41	153H-C16FCD-41
	25	11	15	152H-C25FCD-42	153H-C25FCD-42
	30	15	20	152H-C30FCD-43	153H-C30FCD-43
	37	18.5	25	152H-C37FCD-44	153H-C37FCD-44
	43	22	30	152H-C43FCD-45	153H-C43FCD-45
	43	30	40	152H-C43FCD-46	153H-C43FCD-46
	60	37	50	152H-C60FCD-47	153H-C60FCD-47
	85	45	60	152H-C85FCD-48	153H-C85FCD-48
	85	55	75	152H-C85FCD-49	153H-C85FCD-49
	108	75	100	152H-C108FCD-50	153H-C108FCD-50
	135	90	125	152H-C135FCD-51	153H-C135FCD-51
	201	147	200	152H-C201FCD-54	153H-C201FCD-54
	251	185	250	152H-C251FCD-56	153H-C251FCD-56
317	220	300	152H-C317FCD-57	153H-C317FCD-57	
361	257	350	152H-C361FCD-58	153H-C361FCD-58	
480	375	500	152H-C480FCD-61	153H-C480FCD-61	

\* These controllers require a separate 100...240V, 50/60 Hz single-phase control source. To add a control circuit transformer to the enclosure, add the appropriate option code to the catalog string.

**Two-Wire Configuration**

IEC

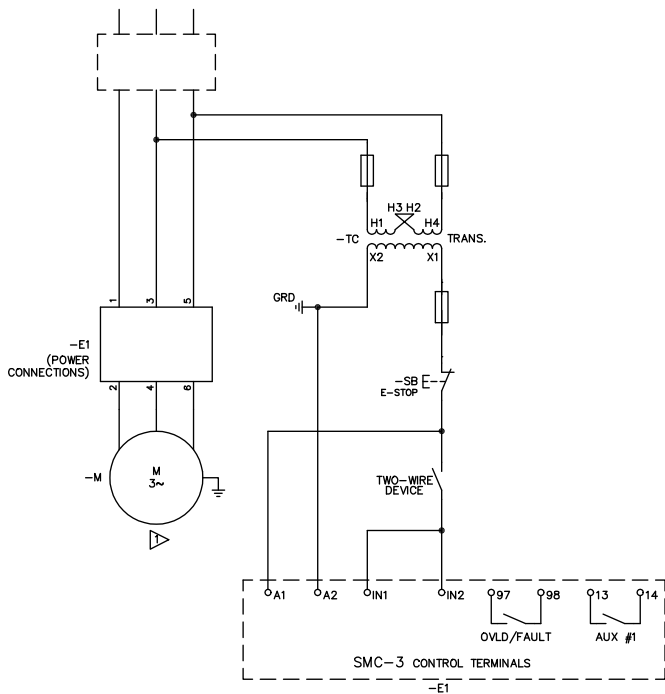

NEMA

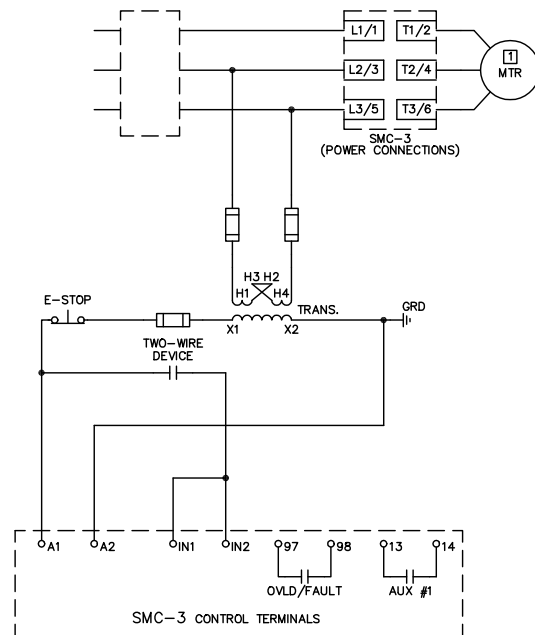

**Three-Wire Configuration**

IEC

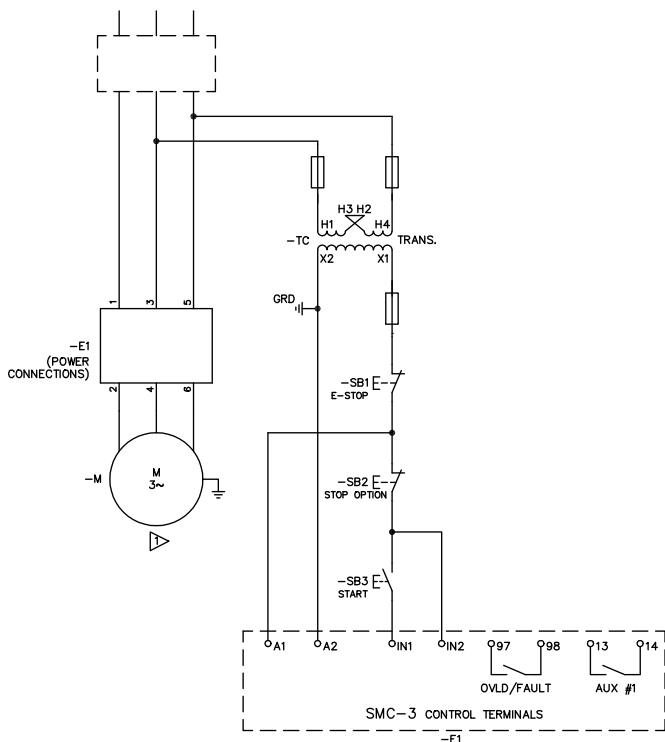

NEMA

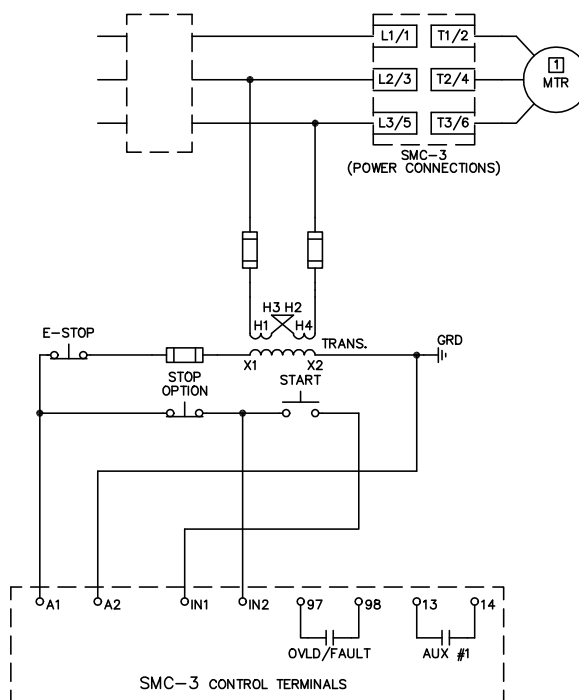



**Isolation Contactor Configuration**

IEC

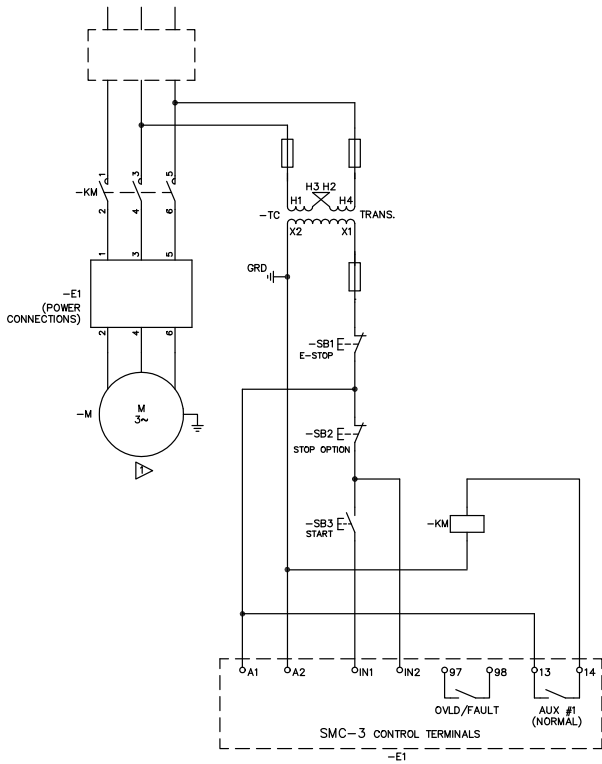

NEMA

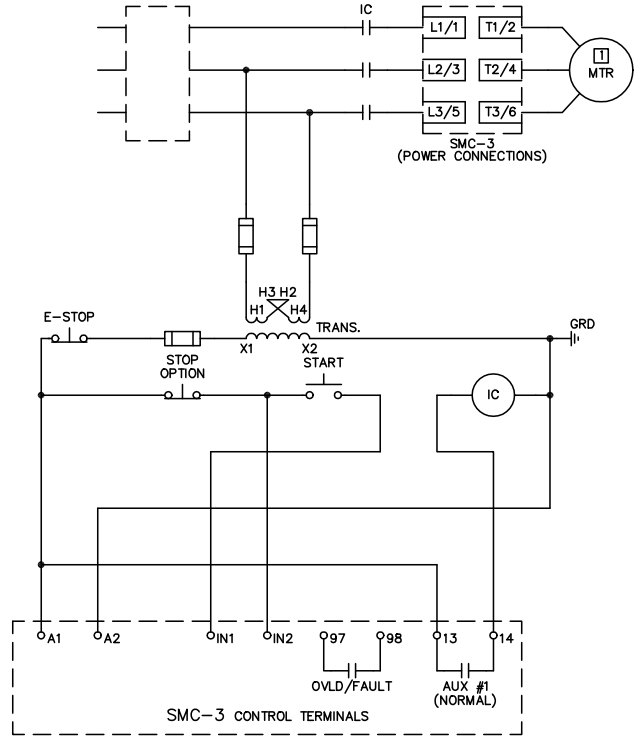

**Reversing Configuration**

Note: Minimum Off time equals 1.0 s.

IEC

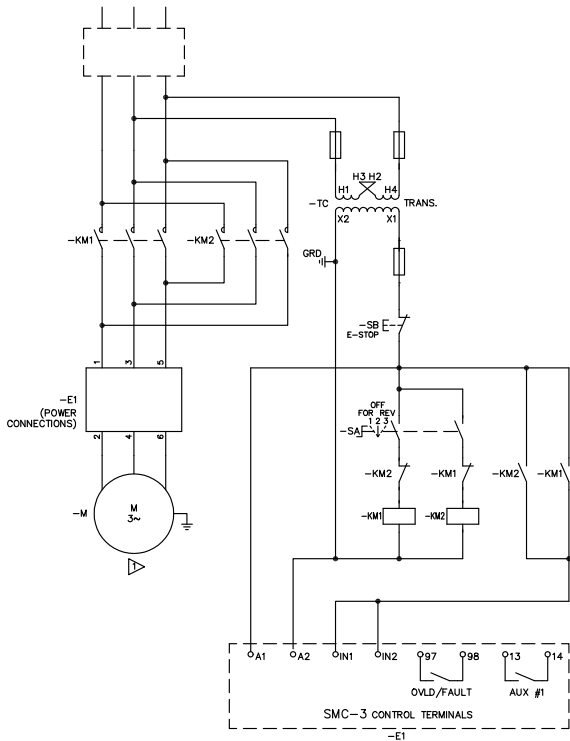

NEMA

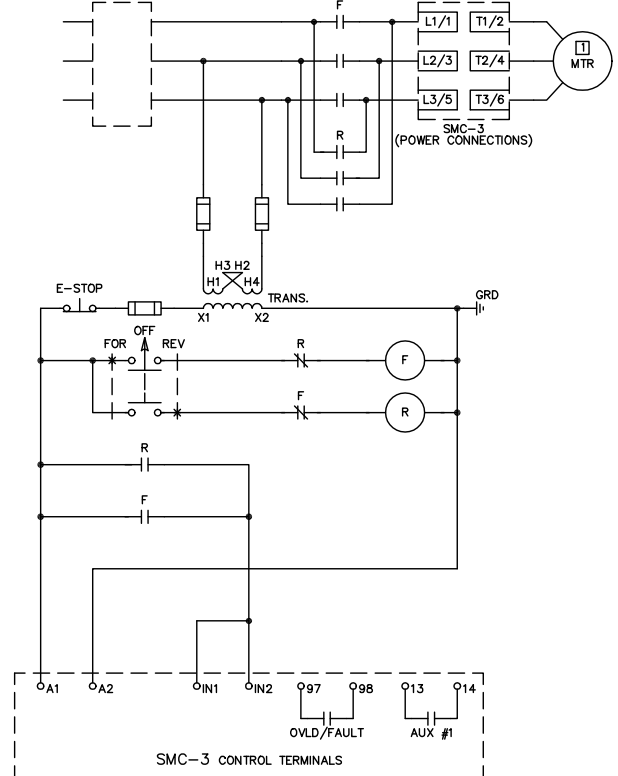

Standard Features								
Selectable Start Times	2, 5, 10, 15, 20, 25, or 30 s							
Selectable Initial Torque	0%, 25%, 35%, and 65% of locked rotor torque							
Selectable Current Limit	150%, 250%, 350%, and 450% of full load current							
Selectable Kick Start — 450% FLA	0, 0.5, 1.0, or 1.5 s							
Selectable Soft Stop	Off, 100%, 200%, or 300% of the start time setting when wired							
Electrical Ratings								
	UL/CSA/NEMA			IEC				
Power Circuit	Rated Operation Voltage	200...480V AC 200...600V AC		200...480V~ — 400V~ 500V~ — 500V~				
	Rated Insulation Voltage	600V AC		500V~				
	Dielectric Withstand	2200V AC		2500V~				
	Repetitive Peak	200...480V AC: 1400V 200...600V AC: 1600V		200...480V~: 1400V 500V~: 1600V				
	Operating Frequency	50/60 Hz		50/60 Hz				
	Utilization Category	1...37 A	—		AC-53b: 3.5-15:3585			
		43...60 A	—		AC-53b: 4.5-30:1770			
		85 A	—		AC-53b: 4.5-30:3570			
		108 A	—		AC-53b: 4.5-30:1770			
		135 A	—		AC-53b: 3.5-30: 1770			
		201...251 A 317...480 A	—		AC-53b: 3.5-30: 1770 AC-53b: 3.5-30: 1770			
	Number of Poles	Equipment designed for 3-phase only						
	Rated Impulse Voltage	6 kV						
	DV/DT Protection	1000V/μs						
	Overvoltage Category	III						
	Type 1							
SCPD Performance	Non-Time Delay		Thermal Magnetic Circuit Breaker		High Capacity Time Delay Class CC/J/L			
SCPD List‡	Max. Standard Available Fault	Max. Standard Fuse (A)*	Max. Standard Available Fault	Max. Circuit Breaker (A)	Max. Standard Available Fault	Max. Fuse (A)		
Line Device Operational Current Rating (A)	3	5 kA	12	5 kA	15	70 kA	6	
	9	5 kA	30	5 kA	30	70 kA	15	
	16	5 kA	60	5 kA	60	70 kA	30	
	19	5 kA	70	5 kA	70	70 kA	40	
	25	5 kA	100	5 kA	100	70 kA	50	
	30	10 kA	110	10 kA	110	70 kA	60	
	37	10 kA	125	10 kA	125	70 kA	60	
	43	10 kA	150	10 kA	150	70 kA	90	
	60	10 kA	225	10 kA	225	70 kA	125	
	85	10 kA	300	10 kA	300	70 kA	175	
	108	10 kA	400	10 kA	300	70 kA	200	
	135	10 kA	500	10 kA	400	70 kA	250	
	201	18 kA	600	18 kA	600	70 kA	350	
	251	18 kA	700	18 kA	700	70 kA	400	
	317	30 kA	800	30 kA	800	69 kA	500	
	361	30 kA	1000	30 kA	1000	69 kA	600	
	480	42 kA	1200	42 kA	1200	69 kA	800	
	Delta Device Operational Current Rating (A)	5.1	5 kA	15	5 kA	15	70 kA	10
		16	5 kA	60	5 kA	60	70 kA	30
		27.6	5 kA	70	5 kA	70	70 kA	60
		32.8	5 kA	125	5 kA	125	70 kA	70
		43	5 kA	150	5 kA	150	70 kA	90
		52	10 kA	200	10 kA	200	70 kA	100
		64	10 kA	250	10 kA	250	70 kA	100
74		10 kA	250	10 kA	250	70 kA	150	
104		10 kA	400	10 kA	300	70 kA	225	
147		10 kA	400	10 kA	400	70 kA	300	
187		10 kA	600	10 kA	500	70 kA	400	
234		10 kA	700	10 kA	700	70 kA	400	
348		18 kA	1000	18 kA	1000	70 kA	600	
435		18 kA	1200	18 kA	1200	69 kA	800	
549		30 kA	1600	30 kA	1600	69 kA	1000	
625		30 kA	1600	30 kA	1600	69 kA	1200	
831		42 kA	1600	30 kA	1600	69 kA	1600	
831		42 kA	1600	42 kA	1200	69 kA	1600	

\* Non-time delay fuses (K5).

‡ Consult local codes for proper sizing of short circuit protection.

Bulletin 150  
**Smart Motor Controllers — SMC™-3**  
 Specifications, Continued

Electrical Ratings				
		UL/CSA/NEMA	IEC	
Rated Operational Voltage (+10%, -15%)		100...240V AC, 24V AC/DC	100...240V~, 24V AC/DC	
Rated Insulation Voltage		250V	250V~	
Rated Impulse Voltage		—	4 kV	
Dielectric Withstand		1500V AC	2000V~	
Overvoltage Category		—	III*	
Operating Frequency		50/60 Hz	50/60 Hz	
Input onstate voltage minimum, during start (IN1, IN2)		85V AC, 19.2V DC / 19.2V AC		
Input onstate current (IN1, IN2)		9.8 mA @ 120V AC / 19.6 mA @ 240V AC, 7.3 mA @ 24V AC/DC		
Input offstate voltage maximum (IN1, IN2)		40V AC, 17V DC / 12V AC		
Input offstate current @ input offstate voltage (IN1, IN2)		<10 mA, <12 mA		
Control Circuit	3...37 A	215 mA @ 120V AC / 180 mA @ 240V AC, 800 mA @ 24V DC / 660 mA @ 24V AC		
	43...85 A	200 mA @ 120V AC / 100 mA @ 240V AC, 700 mA @ 24V AC/DC		
	Control Power with Fan, during start		<b>Fan Power</b>	<b>Control Power</b>
		108...135 A	20 VA	200 mA @ 120V AC / 120 mA @ 240V AC, 600 mA @ 24V AC/DC
		201...251 A	40 VA	
317...480 A	60 VA			
Control Power without Fan, during start	3...37 A	205 mA @ 120V AC / 145 mA @ 240V AC, 705 mA @ 24V DC / 580 mA @ 24V AC		
		<b>Controller Rating (A)</b>	<b>Steady State Heat Dissipation (W)</b>	<b>Overload Current Range (A)</b>
		3	11	1...3
		9	12	3...9
		16	14	5.3...16
		19	15	6.3...19
		25	17	9.2...27.7
		30	19	10...30
		37	24	12.3...37
Steady State Heat Dissipation and Overload Current Range		43	34	14.3...43
		60	50	20...60
		85	82	28.3...85
		108	62	27...108
		135	75	34...135
		201	129	67...201
		251	147	84...251
		317	174	106...317
		361	194	120...361
		480	239	160...480

Auxiliary Contacts			
		UL/CSA/NEMA	IEC
Rated Operational Voltage		250V AC/30V DC	250V~/30V DC
Rated Insulation Voltage		250V	250V~
Rated Impulse Voltage		—	4 kV
Dielectric Withstand		1500V AC	2000V~
Overvoltage Category		—	III*
Operating Frequency		50/60 Hz	50/60 Hz
Utilization Category		D300/D300	AC-15/DC
TB-97, -98 (OVLD/Fault)	Type of Control Circuit	Electromagnetic relay	
	Number of Contacts	1	
	Type of Contacts	Normally Open (N.O.)	
	Type of Current	AC/DC	
	Rated Operational Current (max.)	0.6 A @ 120V~ and 0.3 A @ 240V~	
	Conventional Thermal Current $I_{th}$	1 A	
	Make/Break VA	432/72	
TB-13, -14 (Normal/Up-to-Speed)	Type of Control Circuit	Electromagnetic relay	
	Number of Contacts	1	
	Type of Contacts	Normally Open (N.O.)	
	Type of Current	AC/DC	
	Rated Operational Current (max.)	0.6 A @ 120V~ and 0.3 A @ 240V~	
	Conventional Thermal Current $I_{th}$	1 A	
	Make/Break VA	432/72	

\*Overvoltage category II, when either control or auxiliary circuit is wired to a SELV or PELV circuit.

Electrical Ratings		
Side-Mount Auxiliary Contacts		
	UL/CSA/NEMA	IEC
Rated Operational Voltage	250V AC/30V DC	250V AC/30V DC
Rated Insulation Voltage	250V	250V AC
Rated Impulse Voltage	—	4 kV
Dielectric Withstand	1500V AC	2000V AC
Overvoltage Category	—	III*
Operating Frequency	50/60 Hz	50/60 Hz
	C300/R150	AC-15/DC-13
TB-23, -24 (Normal/Up-to-Speed) TB-33, -34 (Normal/Up-to-Speed)	Utilization Category	Electromagnetic relay
	Type of Control Circuit	1
	Number of Contacts	Normally Open (N.O.)
	Type of Contacts	AC/DC
	Type of Current	1.5 A @ 120V AC, 0.75A @ 240V AC, 1.17 A @ 24V DC
	Rated Operational Current (max.)	2.5 A
	Conventional Thermal Current $I_{th}$	1800/180V AC, 28V DC (resistive)
	Make/Break VA	B300/R300
TB-11, -12 (Normal/Up-to-Speed)	Type of Control Circuit	Electromagnetic relay
	Type of Control Circuit	1
	Number of Contacts	Normally Open (N.O.)
	Type of Contacts	AC/DC
	Type of Current	3 A @ 120V AC, 1.5A @ 240V AC, 1.17 A @ 24V DC
	Rated Operational Current (max.)	5 A
	Conventional Thermal Current $I_{th}$	3600/360 V AC, 28V DC (resistive)
	Make/Break VA	

\*Overvoltage category II, when either control or auxiliary circuit is wired to a SELV or PELV circuit.

Environmental	
Operating Temperature Range	-5...50 °C (23...122 °F) (open) -5...40 °C (23...104 °F) (enclosed)
Storage and Transportation Temperature Range	-25...85 °C (-13...185 °F)
Altitude	2000 m (6560 ft)
Humidity	5...95% (non-condensing)
Pollution Degree	2
Type of Protection	IP2X

Mechanical Ratings		
Resistance to Vibration	Operational	1.0 G Peak, 0.15 mm (0.006 in.) displacement
	Non-Operational	2.5 G Peak, 0.38 mm (0.015 in.) displacement
Resistance to Shock	Operational	15 G
	Non-Operational	30 G
Line Power Terminals	Cable Size Tightening Torque	3...37 A 2.5...25 mm <sup>2</sup> (14...4 AWG) 2.3...2.8 N•m (20...25 in-lbs)
		43...85 A 2.5...95 mm <sup>2</sup> (14...3/0 AWG) 11.3...12.4 N•m (100...110 in-lbs)
		108...135 A 23 N•m (200 in-lbs)
		201...251 A Two M10 x 1.5 diameter holes per power pole
		317...480 A Two M12 x 1.75 diameter holes per power pole
Load Power Terminals	Cable Size Tightening Torque	3...37 A 2.5...16 mm <sup>2</sup> (14...6 AWG) 2.3...2.5 N•m (20...22.5 in-lbs)
		43...85 A 2.5...50 mm <sup>2</sup> (14...1 AWG) 11.3...12.4 N•m (100...110 in-lbs)
		108...135 A 23 N•m (200 in-lbs)
		201...251 A Two M10 x 1.5 diameter holes per power pole
		317...480 A Two M12 x 1.75 diameter holes per power pole
Control Terminals	Cable Size Tightening Torque	All 0.2...2.5 mm <sup>2</sup> (24...14 AWG) 0.5...0.9 N•m (4.4...8.0 in-lbs)
Other		
EMC Emission Levels	Conducted Radio Frequency Emissions	—
	Radiated Emissions	—
EMC Immunity Levels	Electrostatic Discharge	4 kV Contact and 8 kV Air Discharge
	Radio Frequency Electromagnetic Field	—
	Fast Transient	—
	Surge Transient	—

**SMC-3 Overload Trip Curves**

**Trip Class 10**

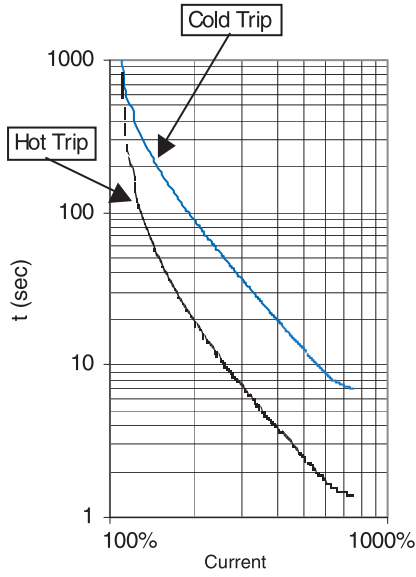

**Trip Class 15**

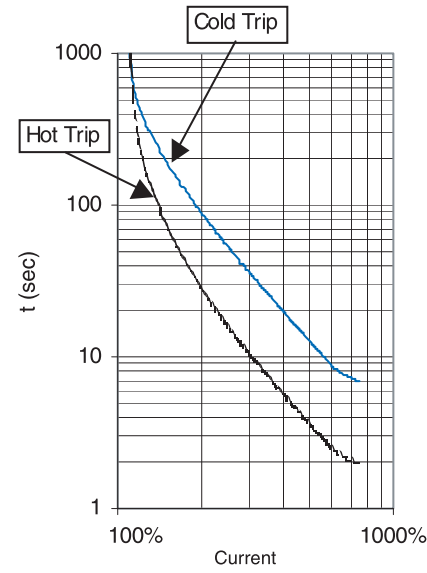

**Trip Class 20**

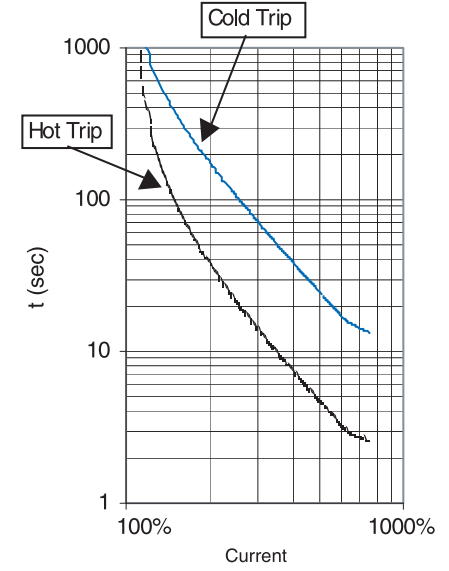

**Starts per Hour Curves**

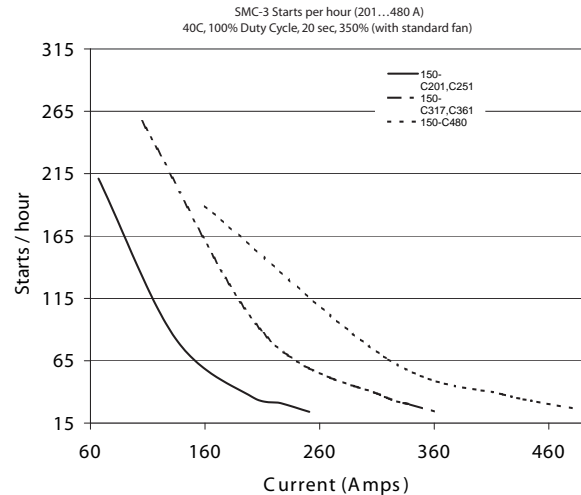
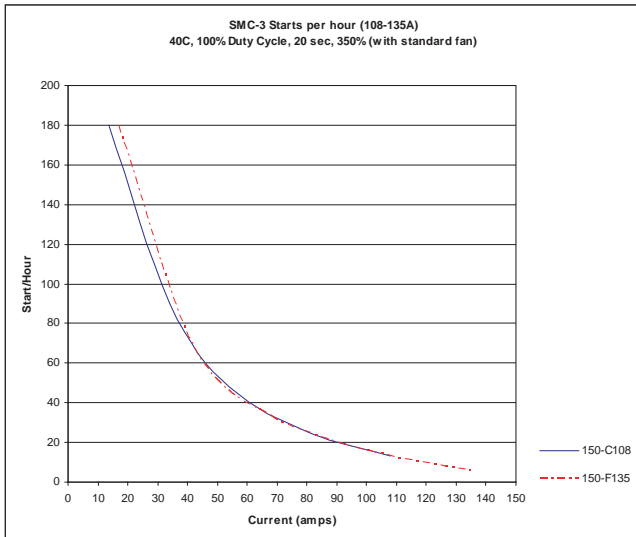
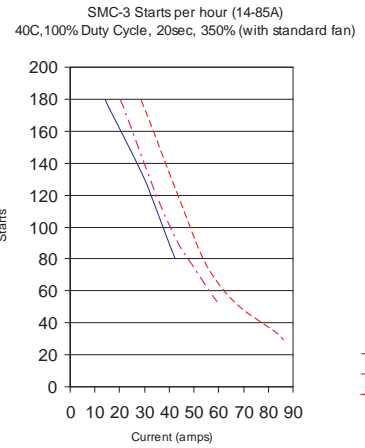
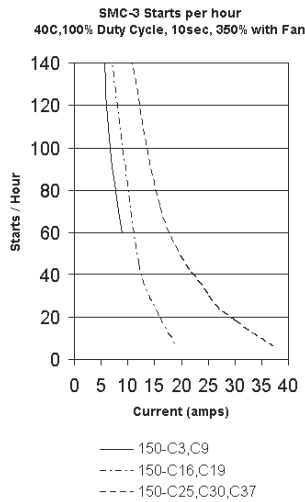
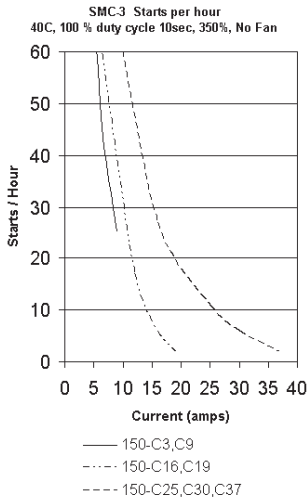

Dimensions in millimeters (inches). Dimensions are not intended to be used for manufacturing purposes. All dimensions are subject to change.

**Open Type**

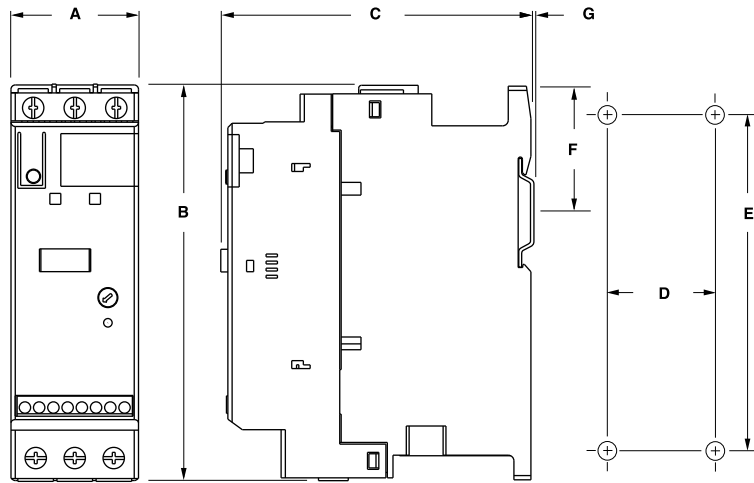

Rating (A)	A	B	C	D	E	F	G	Mounting Hole Size	Weight kg (lbs)
1...37	44.8 (1-49/64)	139.7 (5-1/2)	100 (4-21/64)	35 (1-3/8)	132 (5-13/64)	46.4 (1.81)	2 (1/16)	4.6 (0.18)	0.86 (1.9)
43...85	72 (2.83)	206 (8.11)	130 (5.12)	55 (2.17)	198 (7.8)	102 (4.02)	2 (1/16)	5.3 (0.21)	2.25 (5.0)
108...135	196.4 (7.74)	443.7 (17.47)	205.2 (8.08)	166.6 (6.56)	367 (14.45)	—	—	7.5 (0.295)	15 (33)
201...251	225 (8.86)	560 (22.05)	265.3 (10.45)	150 (5.91)	504.1 (19.85)	—	—	11.5 (0.45)	30.4 (67)
317...480	290 (11.42)	600 (23.62)	298 (11.73)	200 (7.87)	539.2 (21.23)	—	—	11.5 (0.45)	45.8 (101)

**Minimum Enclosure Size**

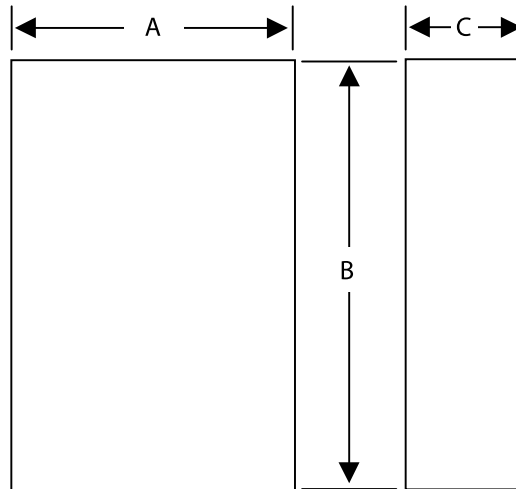

Controller	A Width	B Height	C Depth	Fan Requirements
1...37 A	224 (9)	305 (12)	152 (6)	none
43...85 A	406 (16)	305 (12)	203 (8)	none
108...135 A	762 (30)	610 (24)	305 (12)	none
201...251 A	965 (38)	762 (30)	356 (14)	none
317...480 A	1295 (51)	914 (36)	356 (14)	none

Bulletin 150  
**Smart Motor Controllers — SMC™-3**  
 Approximate Dimensions, Continued

Enclosed Type Line-Connected Controllers

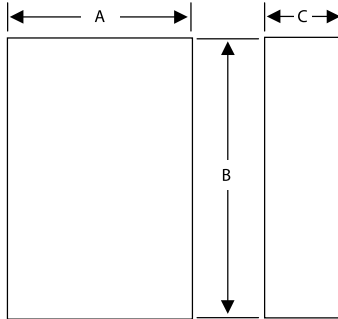

Controller Rating (A)	Disconnect Rating (A)	IP65 (Type 4/12)		
		B Height	A Width	C Depth
<b>Non-Combination Controller</b>				
3	—	305 (12)	305 (12)	152 (6)
9	—	305 (12)	305 (12)	152 (6)
16	—	305 (12)	305 (12)	152 (6)
25	—	305 (12)	305 (12)	152 (6)
30	—	305 (12)	305 (12)	152 (6)
37	—	305 (12)	305 (12)	152 (6)
43	—	356 (14)	406 (16)	203 (8)
60	—	356 (14)	406 (16)	203 (8)
85	—	356 (14)	406 (16)	203 (8)
108	—	762 (30)	610 (24)	305 (12)
135	—	762 (30)	610 (24)	305 (12)
201	—	965 (38)	762 (30)	356 (14)
251	—	965 (38)	762 (30)	356 (14)
317	—	1295 (51)	914 (36)	356 (14)
361	—	1295 (51)	914 (36)	356 (14)
480	—	1295 (51)	914 (36)	356 (14)
<b>Combination Controllers with Fusible Disconnect</b>				
3	30 A/J	356 (14)	406 (16)	203 (8)
9	30 A/J	356 (14)	406 (16)	203 (8)
16	30 A/J	356 (14)	406 (16)	203 (8)
25	30 A/J	356 (14)	406 (16)	203 (8)
30	60 A/J	356 (14)	406 (16)	203 (8)
37	60 A/J	356 (14)	406 (16)	203 (8)
43	60 A/J	356 (14)	406 (16)	203 (8)
60	100 A/J	610 (24)	406 (16)	254 (10)
85*	100 A/J	610 (24)	406 (16)	254 (10)
85*	100 A/J	762 (30)	610 (24)	305 (12)
108	200 A/J	965 (38)	762 (30)	356 (14)
135	200 A/J	965 (38)	762 (30)	356 (14)
201	400 A/J	965 (38)	762 (30)	356 (14)
251	400 A/J	965 (38)	762 (30)	356 (14)
317	600 A/J	1524 (60)	965 (38)	356 (14)
361	600 A/J	1524 (60)	965 (38)	356 (14)
480	600 A/J	1524 (60)	965 (38)	356 (14)
<b>Combination Controllers with Circuit Breaker</b>				
3	15 A	356 (14)	406 (16)	203 (8)
9	15 A	356 (14)	406 (16)	203 (8)
16	20 A	356 (14)	406 (16)	203 (8)
25	30 A	356 (14)	406 (16)	203 (8)
30	40 A	356 (14)	406 (16)	203 (8)
37	50 A	356 (14)	406 (16)	203 (8)
43	80 A	610 (24)	406 (16)	254 (10)
60	100 A	610 (24)	406 (16)	254 (10)
85	125 A	610 (24)	406 (16)	254 (10)
108	175 A/175 A Plug	965 (38)	762 (30)	356 (14)
135	225 A/225 A Plug	965 (38)	762 (30)	356 (14)
201	300 A/300 A Plug	965 (38)	762 (30)	356 (14)
251	400 A/400 A Plug	965 (38)	762 (30)	356 (14)
317	600 A/600 A Plug	1295 (51)	914 (36)	356 (14)
361	600 A/600 A Plug	1295 (51)	914 (36)	356 (14)
480	800 A/800 A Plug	1295 (51)	914 (36)	356 (14)

\* Dimensions for FHD-43, FAD-44, FBD-47, and FCD-48.

\* Dimensions for FHD-44, FAD-45, FBD-48, and FCD-49

### Enclosed Options

Option	Description	Cat. No. Modification
Push Buttons	Start-Stop Push Button	-1
Selector Switch	Hand-Off-Auto Selector Switch	-3
Pilot Light	Transformer Pilot Light - Red Run Indicator	-4R
Control Circuit Transformer	Control Circuit Transformer (fused primary and secondary)	-6P
Protective Module	480V Line Side Protective Module	3...480 A
	600V Line Side Protective Module	3...480 A
	480V Load Side Protective Module	43...480 A
	600V Load Side Protective Module	43...480 A
	480V Both Line and Load Side Protective Module	43...480 A
	600V Both Line and Load Side Protective Module	43...480 A
Auxiliary Contacts	1 N.O. auxiliary contact	for 3...480 A units
	2 N.O. auxiliary contacts	for 3...480 A units
	1 N.O. and 1 N.C. auxiliary contacts	for 3...480 A units
Disconnect Auxiliary	N.O. disconnect auxiliary mounted on the operating mechanism	-98
	N.C. disconnect auxiliary mounted on the operating mechanism	-99

### Accessories

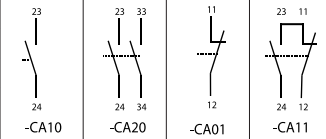

#### Auxiliary Contact Blocks

Description	N.O.	N.C.	Connection Diagram	Cat. No.
 <b>Auxiliary Contact Blocks for side mounting with sequence terminal designations</b> 1- and 2-pole Quick and easy mounting without tools One block per device only	1	0		150-CA10
	2	0		150-CA20
	0	1		150-CA01
	1	1		150-CA11 (Form C)

### Fans

Description	For Use With	Pkg. Qty.	Cat. No.
 <b>Fan</b> Field installed	Optional 150-C3...37 150-D3...64	1	150-CF64
	Replacement 150-C43...85/150-D74...147		150-CF147
	150-C108, 150-C135		41391-801-03
	150-C201, 150-C251		41391-801-01
	150-C317...C480		41391-801-02

### Connecting Modules

Description	For Use With	Pkg. Qty.	Cat. No.
 <b>Connecting modules to 140-M</b> Electrical interconnection between SMC-Delta/SMC-3 and 140-M. Motor protector and SMC must be mounted separately.	Connects 140-M-C to 150-C3...25/150-D3...25	1	150-CC25
	Connects 140-M-D to 150-C3...25/150-D3...25	1	150-CD25
	Connects 140-M-F to 150-C3...37/150-D3...32	1	150-CF45
 <b>Connecting modules to 100-C</b> Electrical interconnection between SMC-Delta/SMC-3 and 100-C. Contactor and SMC must be mounted separately.	Connects 100-C09...23 to 150-C3...19/150-D3...20	1	150-CI23
	Connects 100-C30...37 to 150-C3...37/150-D3...32	1	150-CI37



**Protective Modules**

Protective modules must not be placed on the load side of a device when using an inside-the-delta connection.

Description		For Use With	Pkg. Qty.	Cat. No.
	<b>480V Protective Module</b>	150-C3...37NB or 150-D3...64NB (line only)	1	150-C84
		150-C43...85NB (line and/or load) or 150-D74...147NB (line only)	1	150-C84P
		150-C108...480NB (line and/or load)	1	150-F84L
	<b>600V Protective Module</b>	150-C3...37NC or 150-D3...64NC (line only)	1	150-C86
		150-C43...85NC (line and/or load) or 150-D74...147NC (line only)	1	150-C86P
		150-C108...480NC (line and/or load)	1	150-F86L

**IEC Terminal Covers**

Description		For Use With	Pkg. Qty.	Cat. No.
	<b>Terminal Cover</b> IEC line or load terminal covers for 108...480 A devices. Dead front protection	150-C108...-C135	1	150-TC1
		150-C201...-C251	1	150-TC2
		150-C317...-C480	1	150-TC3

**Terminal Lug Kits (108...1250 A)**

	Current Rating (A) *	Wire Size	Total No. of Line Controller Terminal Lugs Possible Each Side		Pkg. Qty.	Cat. No.
			Line Side	Load Side		
	108...135♣	#6...250 MCM AWG 16 mm <sup>2</sup> ...120 mm <sup>2</sup>	3	3	3	199-LF1
	201...251♣		6	6		
	317...480♣	#4...500 MCM AWG 25 mm <sup>2</sup> ...240 mm <sup>2</sup>	6	6		199-LG1

Line and Load terminals are provided as standard on enclosed SMCs.

\* 1...85 A units have box lugs standard. No additional lugs are required.

♣ When a multi-conductor lug is required, refer to the Instruction Sheet for appropriate lug catalog number.

**Marking Tags and Covers**

Description		For Use With	Pkg. Qty.	Cat. No.
	<b>Marking Tag Sheet</b> 160 perforated paper labels each, 6 x 17 mm To be used with a transparent cover	150-C, 150-D	10	100-FMP
	<b>Transparent Cover</b> To be used with marking tag sheets	150-C, 150-D	100	100-FMC

**Remote Reset Solenoid**

Description		For Use With	Pkg. Qty.	Cat. No.
	<b>Remote Reset Solenoid</b> for remote reset of electronic overload	193-T all, 150-C, 150-D	1	193-ER1⊗

⊗ **Voltage Suffix Code**

Available Coil Voltages 12... 600V 50 Hz/12...600V 60 Hz

Standard Coil Voltages

Voltage	24	48	110	115	120	220	240
50 Hz	J	—	D	—	—	A	—
60 Hz	J	—	—	—	D	—	A
DC	Z24	Z48	—	Z01	—	—	—

Surcharge for special voltages up to 20 pcs. (no surcharge for quantities greater than 20 pcs.)